

XP[®] MOMENTUM

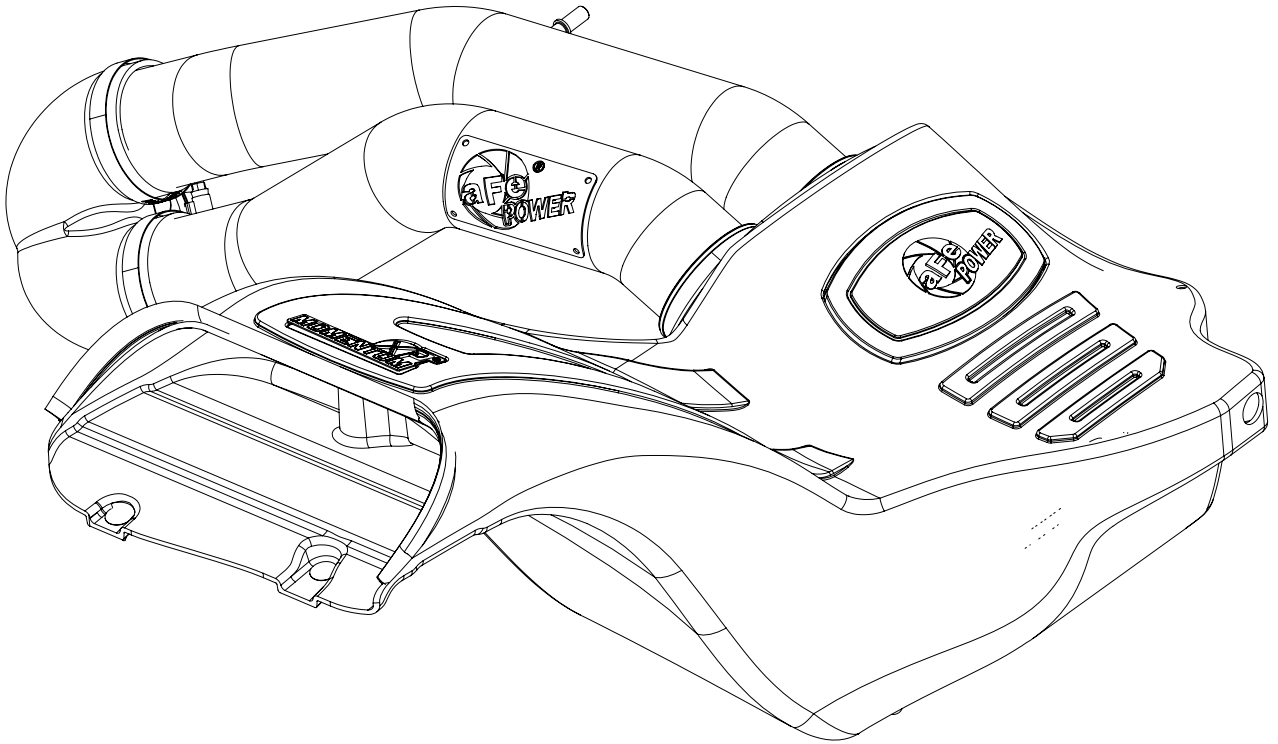

advanced FLOW engineering Momentum XP Cold Air Intake System

Instruction Manual P/N: 50-30024D/R / 50-30024DH/RH / 50-30024DL/RL

Make: **Ford** Model: **F-150** Year: **2015-2020** Engine: **V8-5.0L**



- Please read the entire instruction manual before proceeding.
- Ensure all components listed are present.
- If you are missing any of the components, call customer support at 951-493-7185.
- Ensure you have all necessary tools before proceeding.
- Do not attempt to work on your vehicle when the engine is hot.
- Retain factory parts for future use.

Label	Qty.	Description	Part Number
A1	1	Air Filter (Pro DRY S)	21-91115
A2	1	Air Filter (Pro 5R)	24-91115
B	1	Housing	05-5030024B3
C1	1	Tube 1 of 2: Black	05-5030024B1
C2	1	Tube 1 of 2: Brushed	05-5030024H1
C3	1	Tube 1 of 2: Blue	05-5030024L1
D1	1	Tube 2 of 2: Black	05-5030024B2
D2	1	Tube 2 of 2: Brushed	05-5030024H2
D3	1	Tube 2 of 2: Blue	05-5030024L2
E	1	Hose, Silicone Elbow: (90 Degree)	05-01493
F	1	Clamp, #056	03-50009
G	2	Clamp, #048	03-50007
H	2	Retainer Clip	03-50616
I	1	Seal, Trim: 7/16" (15-1/2" in.)	05-00072

Installation will require the following tools:

7mm/8mm/nut driver or deep sockets, flat head screw driver, 13mm socket and driver, panel popper tool.

Warranty Information available at <https://afepower.com/contact#warranty>

Note: Legal in California for use on race vehicles only. The use of this device on vehicles used on public streets or high-ways is strictly prohibited in California and others states that have adopted California emission regulations.

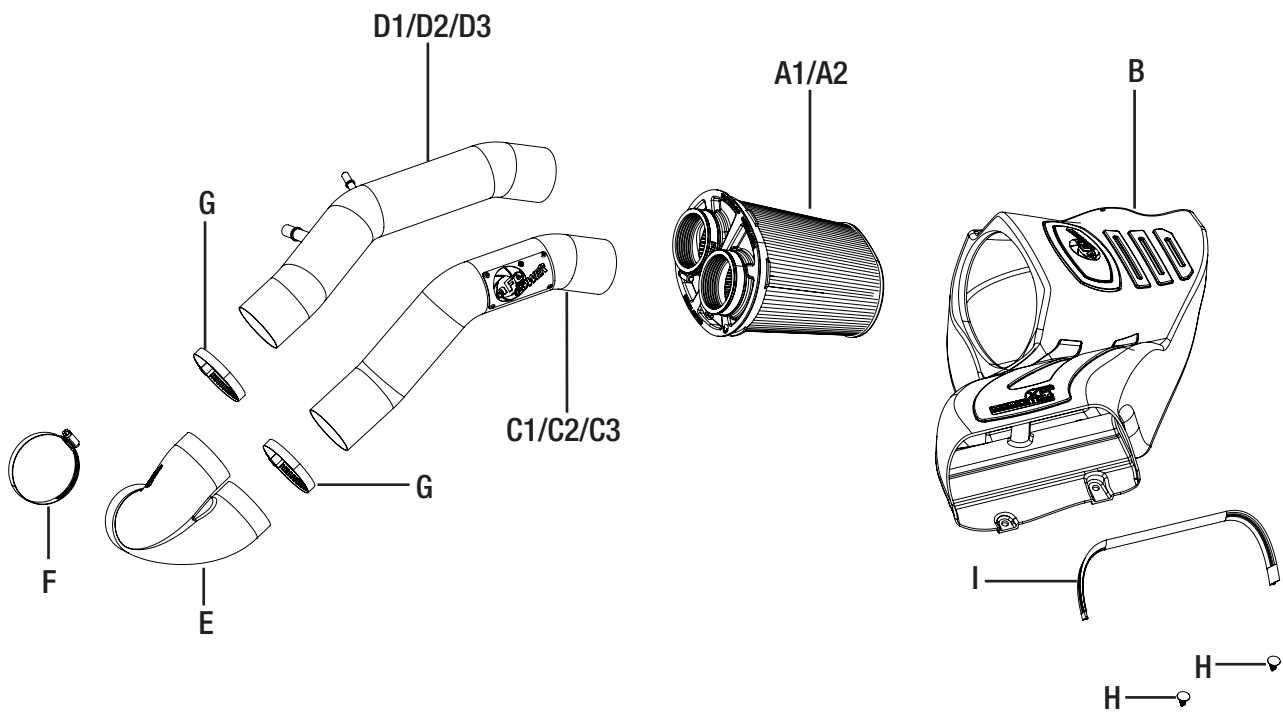

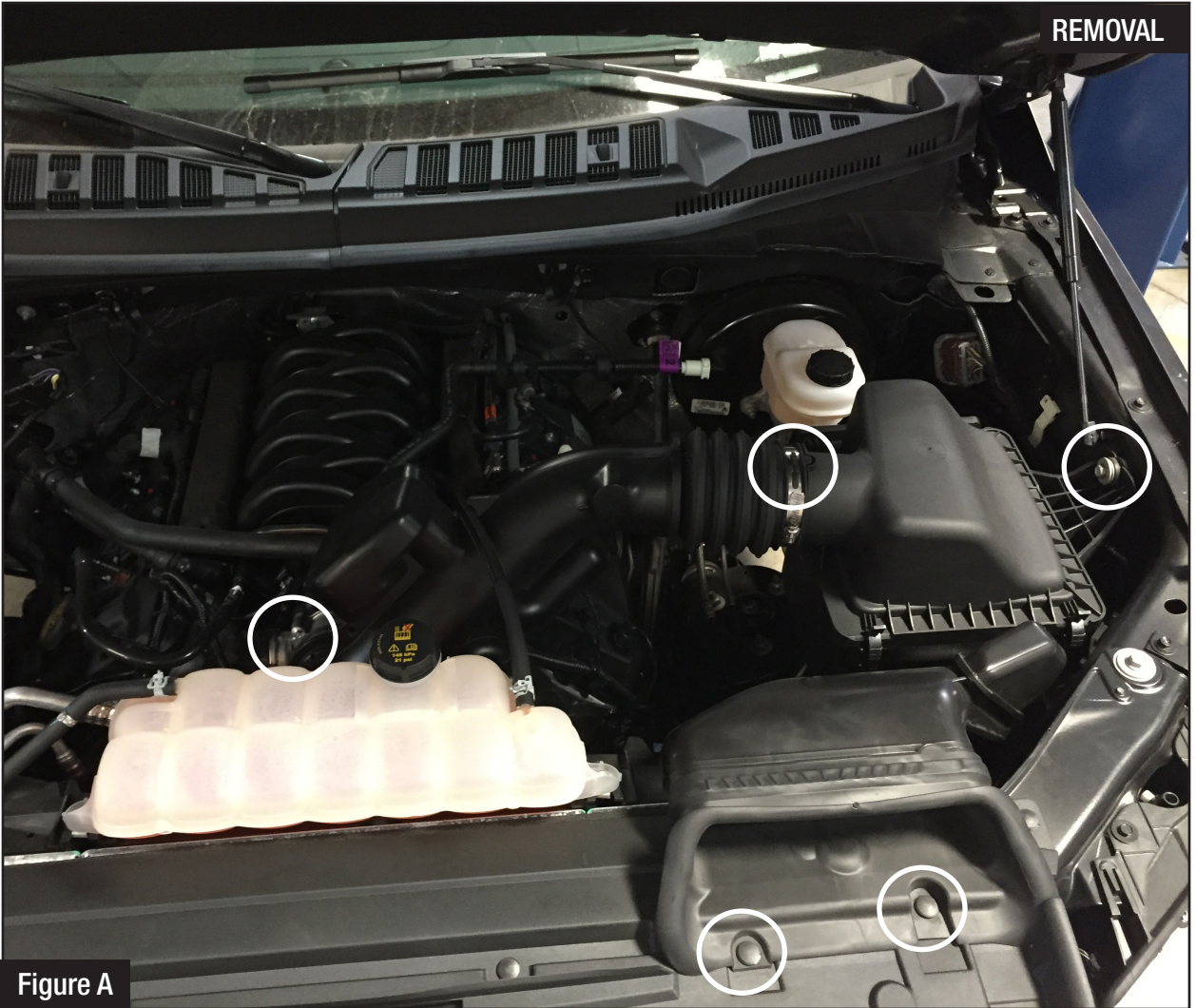

Figure A

Refer to Figure A for Steps 1-4

Step 1: Un-snap coolant hose from tubes.

Step 2: Disconnect the two crankcase breather lines.

Step 3: Untighten the two clamps on the air intake tube. Pull the tube out of the truck.

Step 4: Remove the screw and the two plastic rivets securing the housing, then pull the factory airbox out of the truck.

NOTE: Some models will have a wiring harness attached to the airbox, unclip the harness if it is present.



Refer to Figure B for Steps 5-6

Step 5: Transfer the grommet and sleeve from the factory airbox to the aFe POWER housing.

Step 6: Install the furnished seal trim on the top edge of the aFe POWER housing.

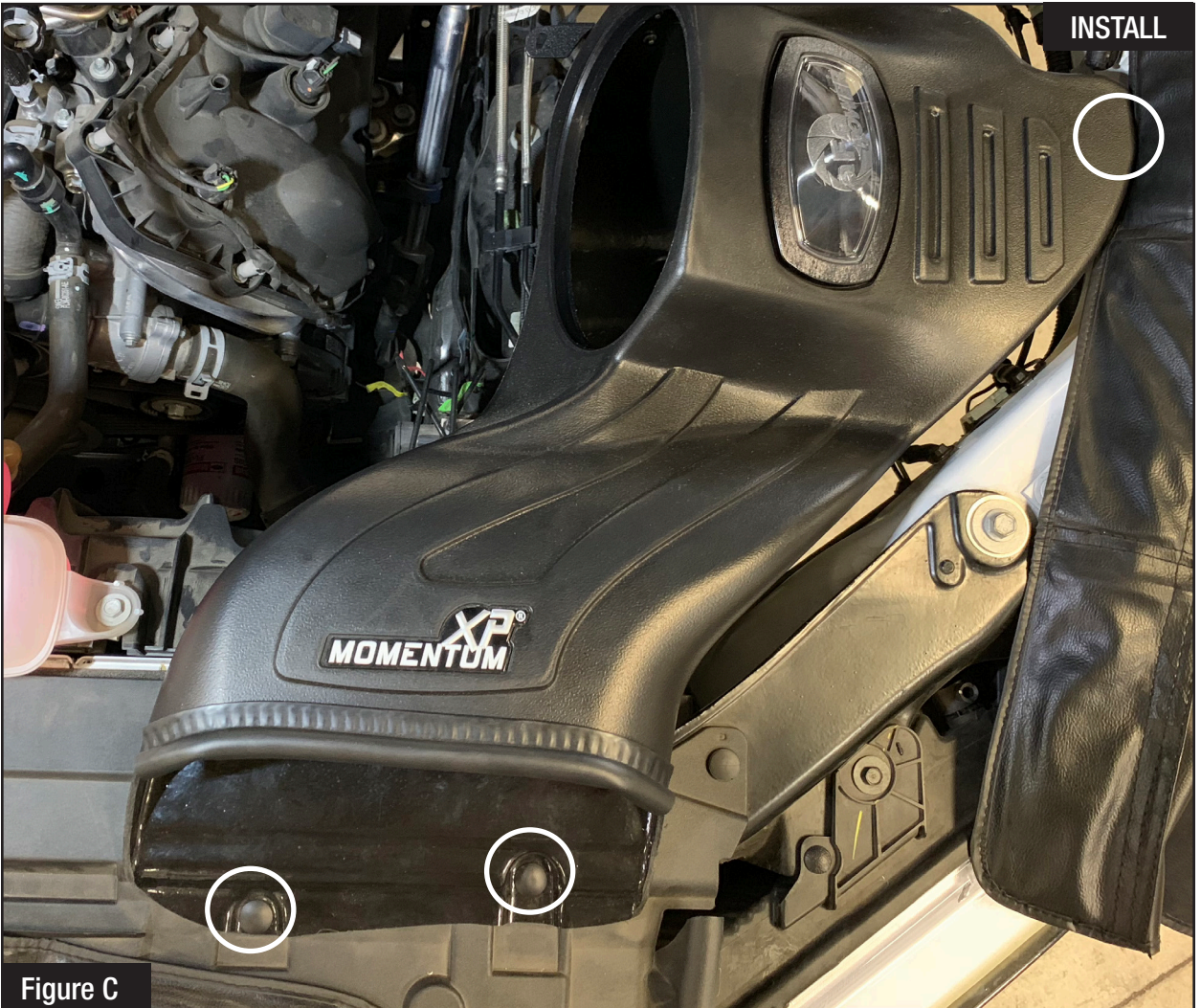

Figure C

Refer to Figure C for Steps 7-9

- Step 7: Install the aFe POWER housing into the truck by pushing it into the factory mounting grommets.
- Step 8: Re-install the factory screw removed in Step 4, inside the aFe POWER housing.
- Step 9: Secure the housing with the two furnished plastic rivets and secure the factory wiring harness to the back of the housing if your vehicle is equipped with one.



Figure D

Refer to Figure D for Step 10

Step 10: Slide the aFe POWER air filter inside the housing until it locks in place. Install the clamps on the air filter but do not tighten.

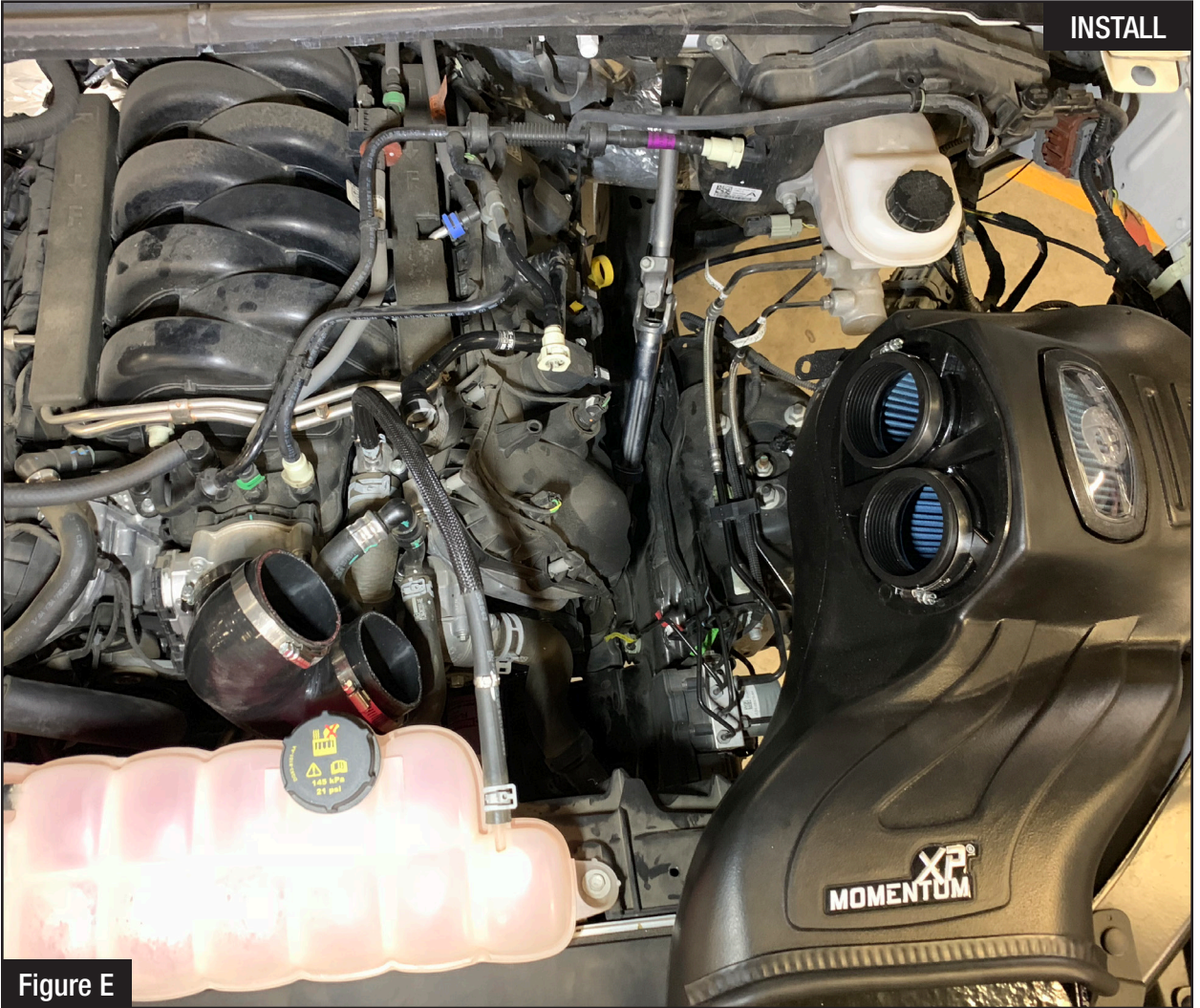

Figure E

Refer to Figure E for Step 11

Step 11: Install the coupling and clamps onto throttle body. Do not tighten clamps yet.



Figure F

Refer to Figure F for Step 12

Step 12: Install the aFe POWER tube with the badge into the lower inlet of the coupling then into the first inlet of the air filter. Do not tighten clamps yet.



Figure G

Refer to Figure G for Steps 13-14

Step 13: Install the second aFe POWER tube into the top inlet of the coupling then into the air filter inlet.

Step 14: Align the tubes correctly then tighten all clamps.

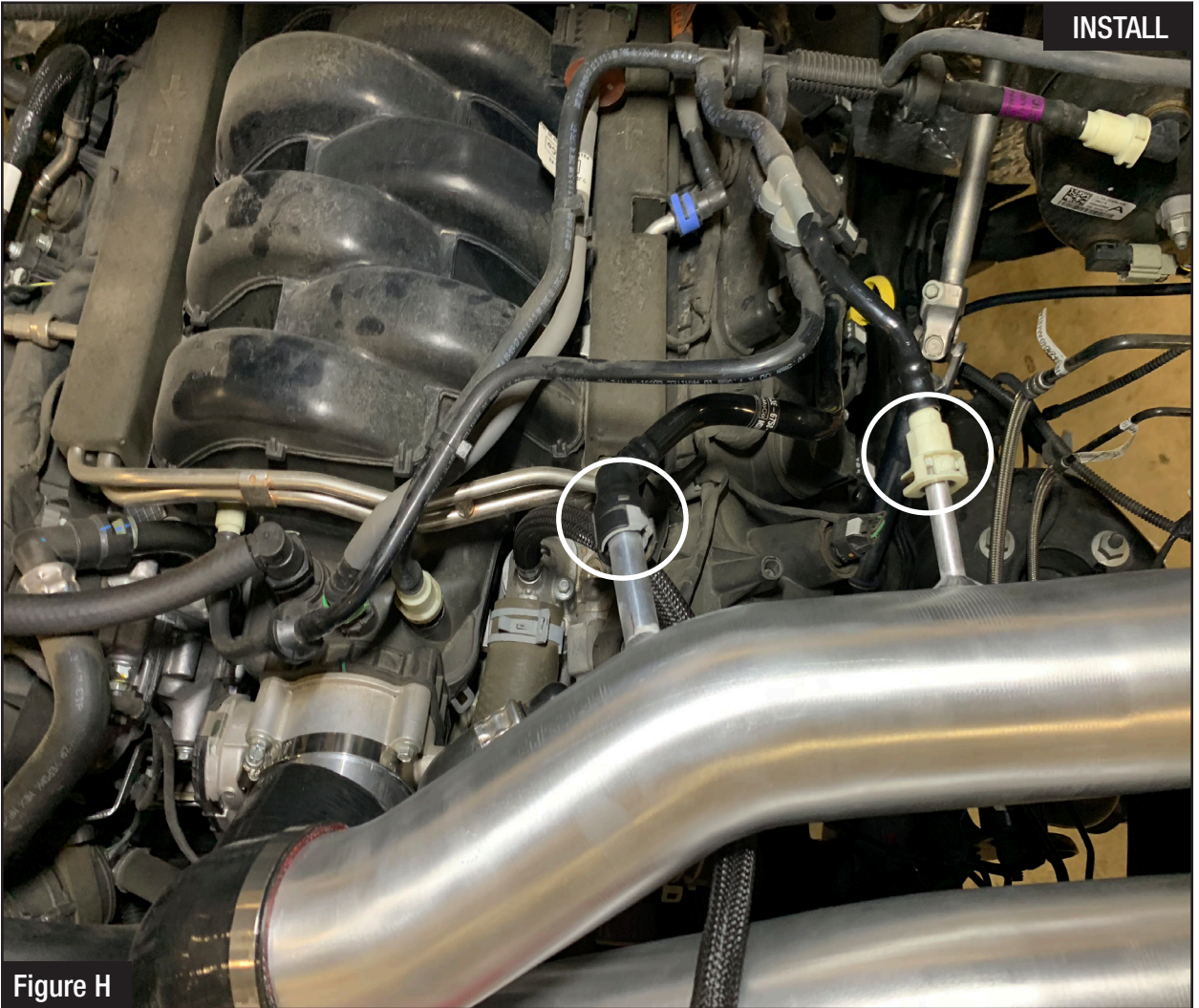

Figure H

Refer to Figure H for Step 15

Step 15: Reconnect the two crankcase breather lines to the aFe POWER tube.



Figure 1

Refer to Figure 1 for Step 29

Step 16: Make sure all clamps and screws are secured. Your installation is now complete.

NOTE: Check all bolts, clamps, and connectors after 100-200 miles.

Page left blank intentionally

Page left blank intentionally

Page left blank intentionally

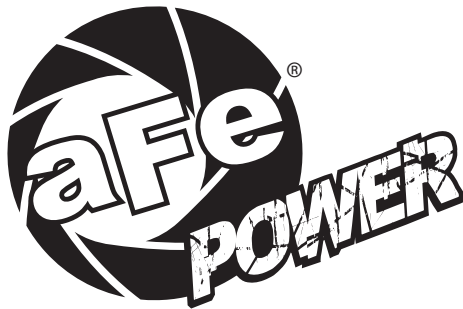

advanced FLOW engineering, inc.

252 Granite Street Corona, CA 92879

<https://afepower.com/contact>