

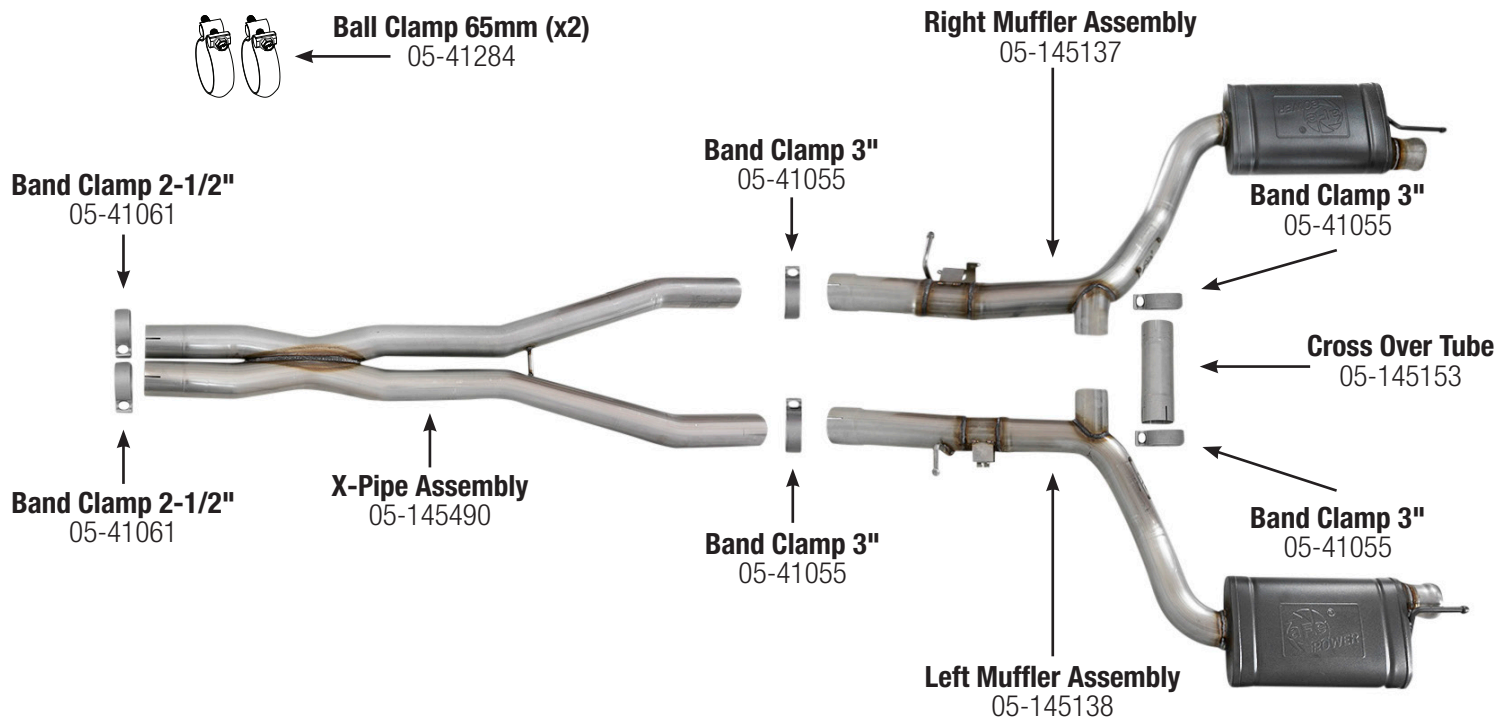

INSTALLATION INSTRUCTIONS

MAKE: Dodge
MODEL: Challenger R/T
YEAR: 2017 - 2019
ENGINE: V8-5.7L HEMI

Cat-Back Exhaust
49-32061



Caution: aFe recommends professional installation on our products. Allow time for your vehicle to cool down prior to installation. When working on or under your vehicle proceed with caution. Exhaust systems reach high temperatures and may cause serious burns. Wear protective safety equipment; eye goggles and gloves to ensure a safe installation.

- Step 1: (Read instructions prior to installation.)** Secure vehicle on jack stands (refer to your owner's manual for specified jack stand locations).
- Step 2:** Disconnect the battery.
- Step 3:** Disconnect the factory ground strap from the muffler hanger on the rear of the OE exhaust system.
- Step 4:** Remove the Right and Left exhaust tips from the OE mufflers.
- Step 5:** Unplug the wire harness from the right and left exhaust valve actuators.
- Step 6:** Loosen the band clamps on the OE exhaust system to connection pipes.
- Step 7:** Remove the rubber isolation mounting brackets from the chassis and remove the OE exhaust system.
- Step 8:** Remove the exhaust valve actuators from the OE exhaust and install them on the right and left aFe power mufflers using the supplied hardware see Fig 1. (Make sure you mark the exhaust valve actuators right and left to reinstall them on the correct side).
- Step 9:** Slide the 2-1/2" band clamps on the aFe power X-pipe inlets and install X-pipe onto the OE connection pipes, do not tighten the clamps.
- Step 10:** Remove the rubber isolation mounts from the OE exhaust and reinstall them onto the aFe power right and left mufflers.
- Step 11:** Slide the 3" band clamps onto the right and left aFe power inlets, slide the 3" band clamps onto the ends of the cross over tube and slide onto the aFe power mufflers, do not tighten.
- Step 12:** Install the aFe power mufflers onto the aFe power X-pipe, do not tighten.
- Step 13:** Reinstall the rubber isolation mounts and tighten.



INSTALLATION INSTRUCTIONS

MAKE: Dodge
MODEL: Challenger R/T
YEAR: 2017 - 2019
ENGINE: V8-5.7L HEMI

Cat-Back Exhaust
49-32061

Figure 1

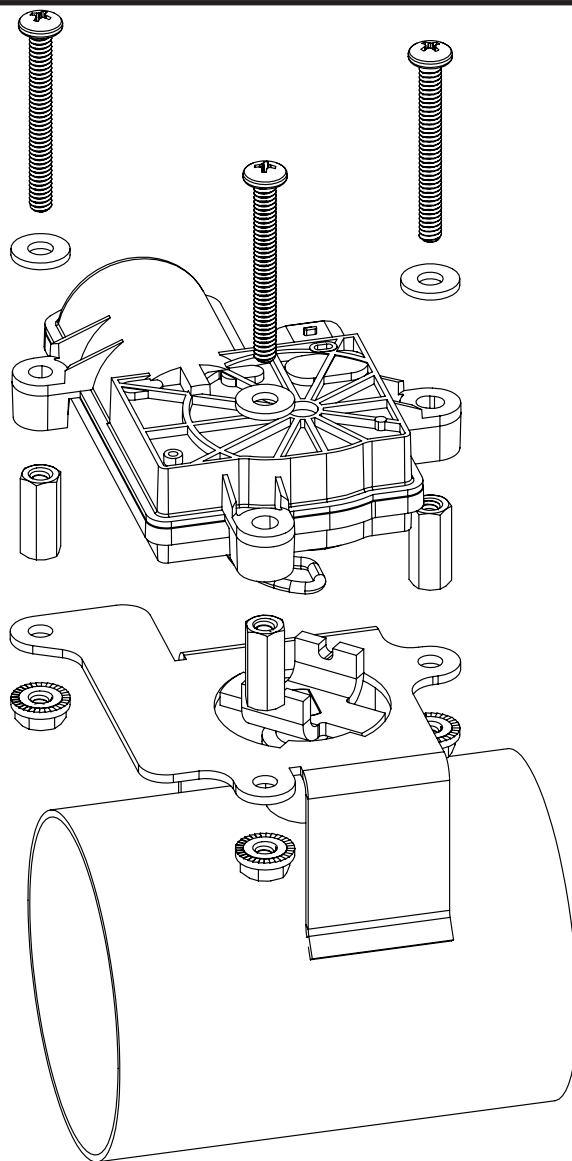

Caution: aFe recommends professional installation on our products. Allow time for your vehicle to cool down prior to installation. When working on or under your vehicle proceed with caution. Exhaust systems reach high temperatures and may cause serious burns. Wear protective safety equipment; eye goggles and gloves to ensure a safe installation.

Step 14: Once position of the aFe power exhaust system has been determined for proper alignment and clearance tighten all band clamps.

Step 15: Reinstall the wire harness on the right and left exhaust valve actuators.

Step 16: Install the right and left OE exhaust tips.

Step 17: Double check all work and ensure everything is tight. Make sure to check all wires, hoses, brake lines, body parts and tires have clearance from the exhaust system.

Step 18: Reconnect the battery.

Step 19: Start the vehicle and check for exhaust leaks.

Step 20: Remove the vehicle from the jack stands.

Step 21: Your installation is now complete.

Step 22: It is recommended to re-tighten all clamps and bolts after 50-100 miles.