



INSTALLATION INSTRUCTIONS

MAKE: Toyota

MODEL: Tacoma

YEAR: 2016-2020

ENGINE: V6-3.5L

WHEELBASE: ACSB, ACLB, CCSB, CCLB

3" Cat-Back
49-46026-B (Black Tip)
49-46026-P (Polished Tip)

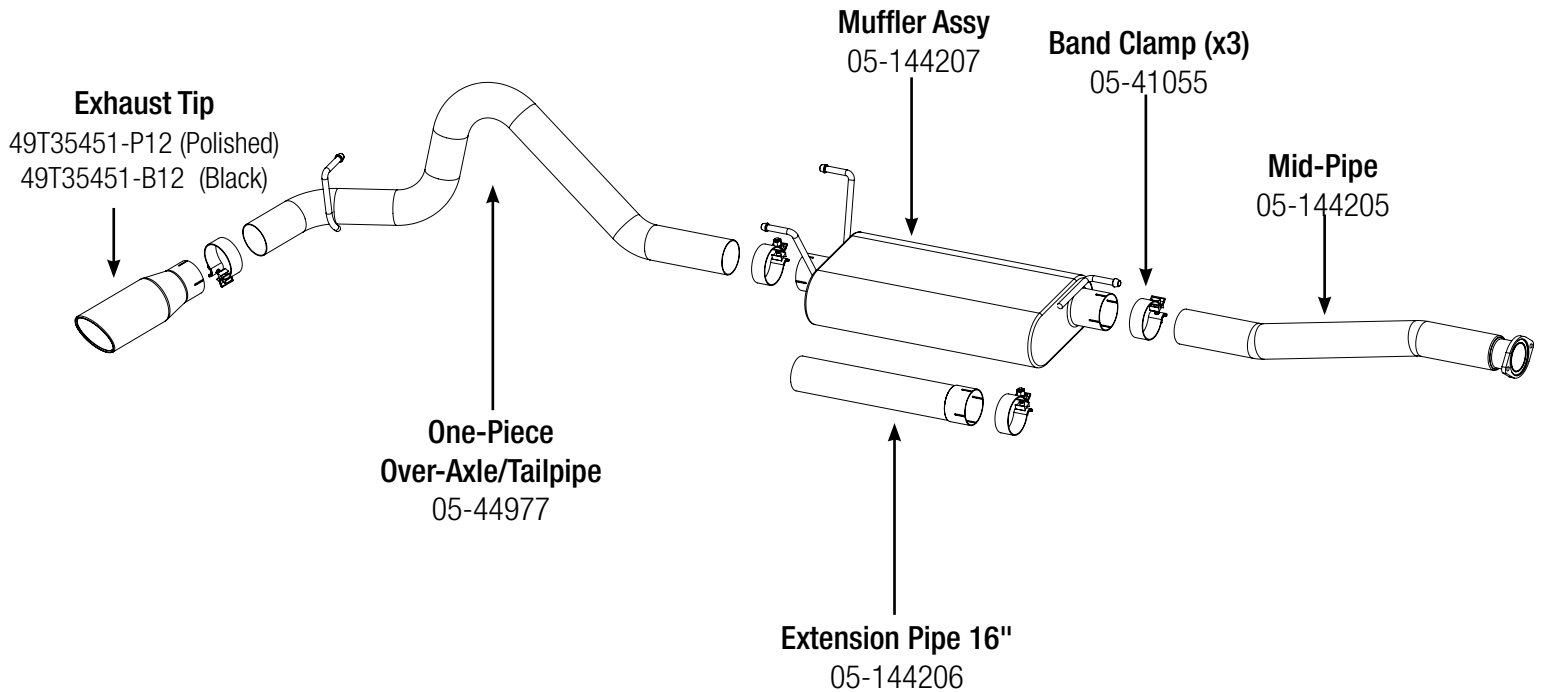

Step 1: (Read Instructions prior to installation) Remove your stock exhaust up to the catalytic converter from the rear of your truck working your way forward. Take caution not to damage the factory hardware and isolation mounts as they will be reused.

It is recommended to not fully tighten the clamps until the entire system has been installed.

Step 2: For faster installation spread the pieces of the exhaust along side of your vehicle according to the diagram shown.

Step 3: Install midpipe assembly using the OE hardware and gasket.

Step 4: For the 127.8 "WB AC/SB, AC/LB, and CC/SB, does not use extension pipe. For the 140.6 WB CC/LB Install 3" band clamp onto the extension and slide the extension pipe onto the midpipe.

Step 5: Install muffler assembly using the factory isolation mounts and provided 3" clamps.

Step 6: Using the 3" band clamp install the tailpipe and tip. Align system and tighten all bolts and clamps.

Step 7: Your installation is now complete. It is recommended to re-tighten all exhaust components after 50-100 miles.

NOTES:

- aFe recommends that the tailpipe be at least 1/2"-1" away from any body panels to avoid heat related body damage. **Tighten and secure.**

Caution: Allow time for your vehicle to cool down prior to installation. When working on or under your vehicle proceed with caution. Exhaust systems reach high temperatures and may cause serious burns. Wear protective safety equipment; eye goggles and gloves to ensure a safe installation. **aFe recommends professional installation on our products.**